

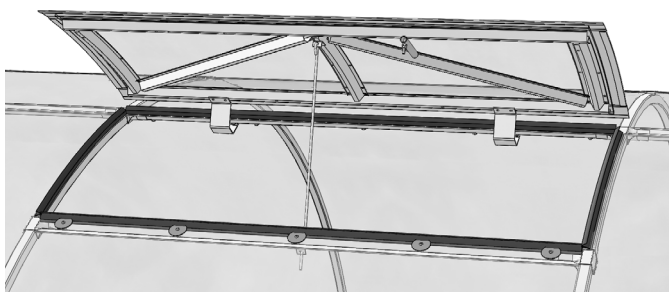

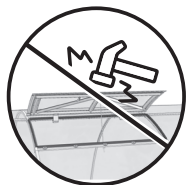



















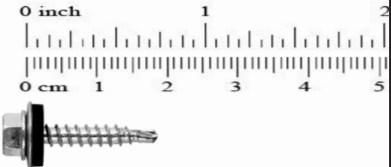

SMALL WINDOW
for the greenhouses «Sigma»
Step arcs 1 m



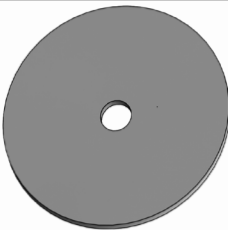

№1				
1	C.02		0.98 m	x1
2	1		0.95 m	x2
3	2		0.29 m	x3
4	3		0.49 m	x2
5	-		0.29 m	x1
6			0.33 m	x2
7			1.02 m	x2
8			0.98 m	x2
			0.41 m	x2
9			0.97 m	x2
№2				
10				x2
11				x1
12				x2
13				x2
14				x2
15				x1
16				x1

17	4,8x19		6
18	M4x8		31
19	M4x14		21
20	M4x35		10
21	M4x50		1
22	M5x45		2
23	M4		65
24	M5		2
25	32x4		11

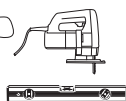

1

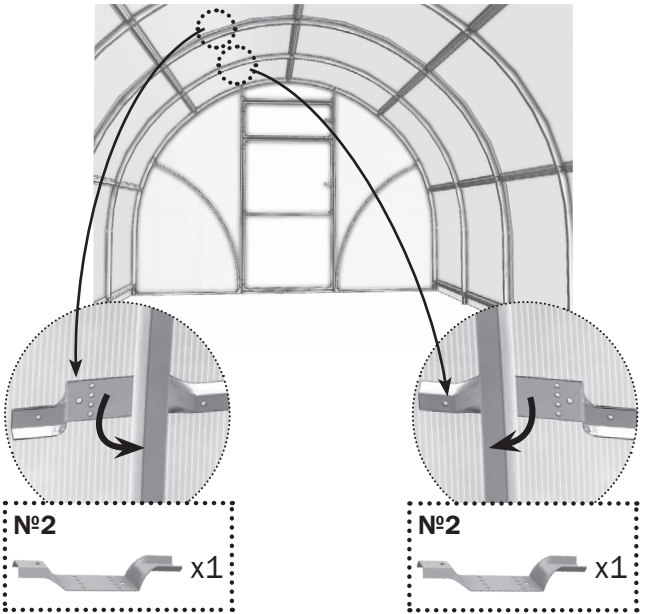

2

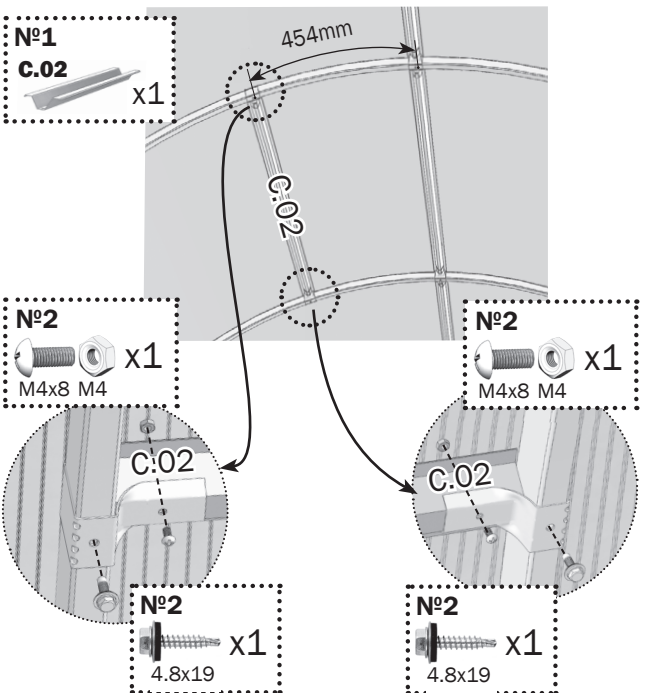

3

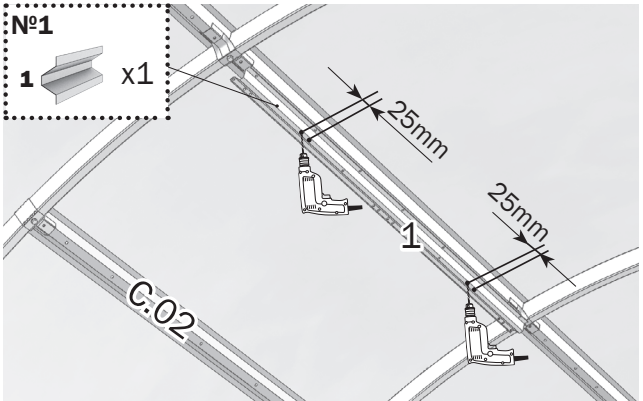

4

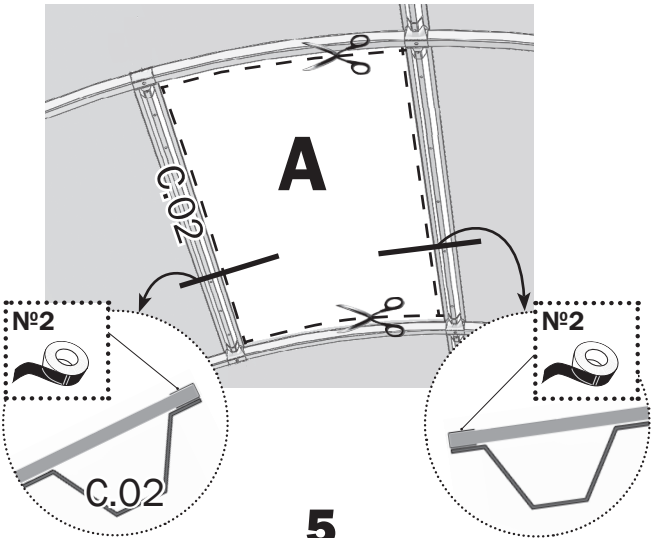

5

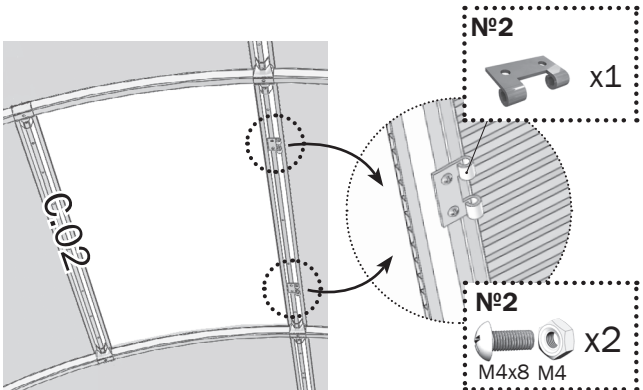

6

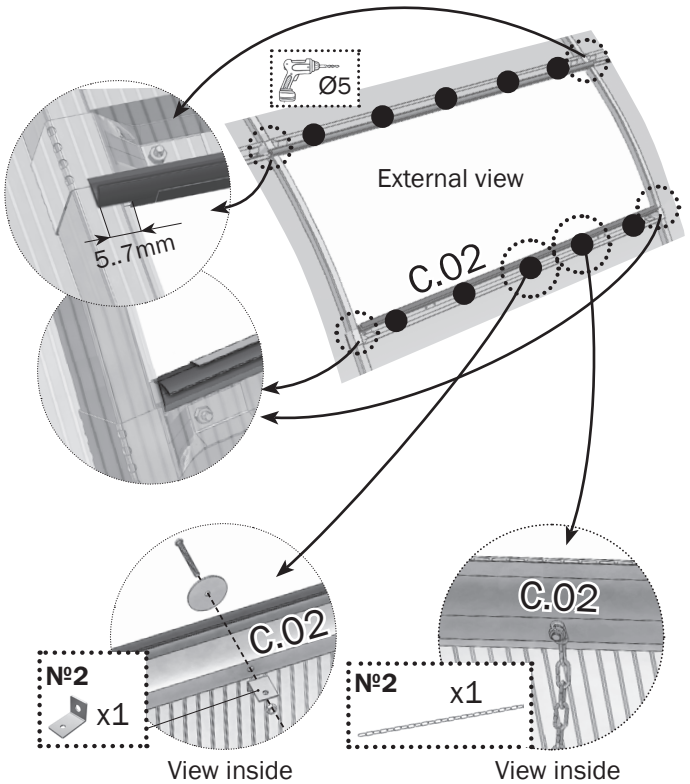
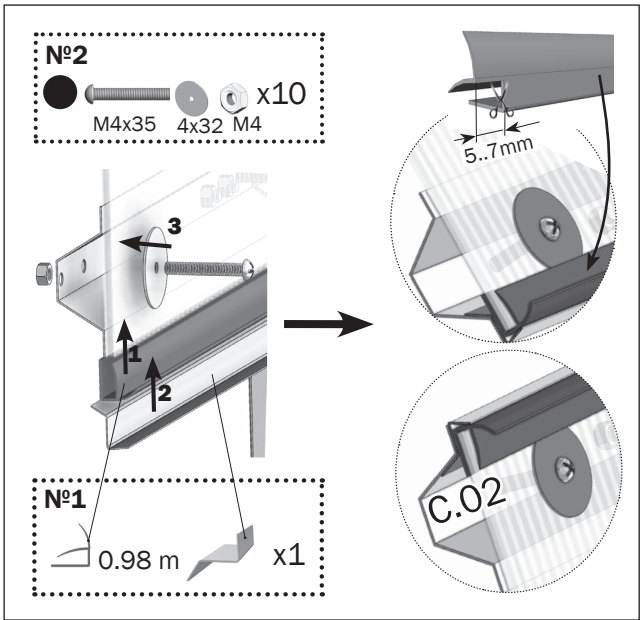

7

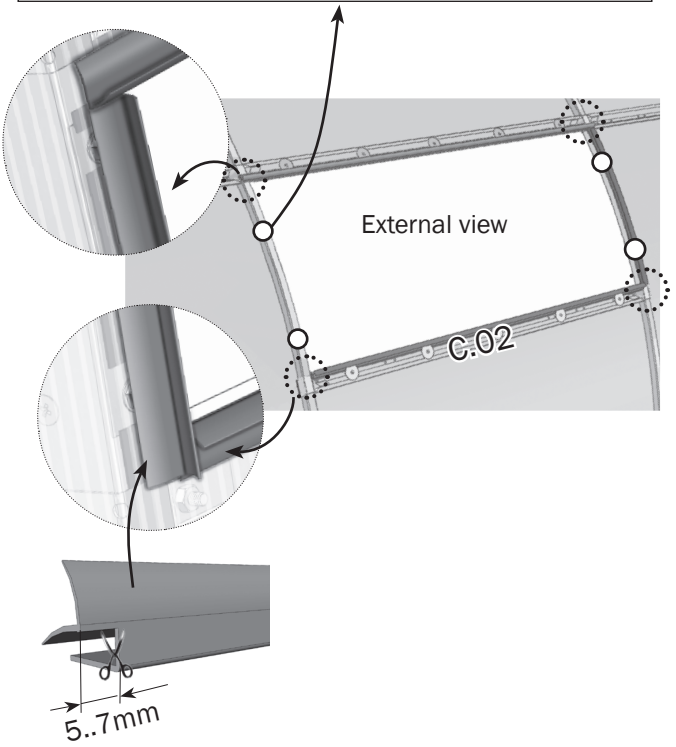
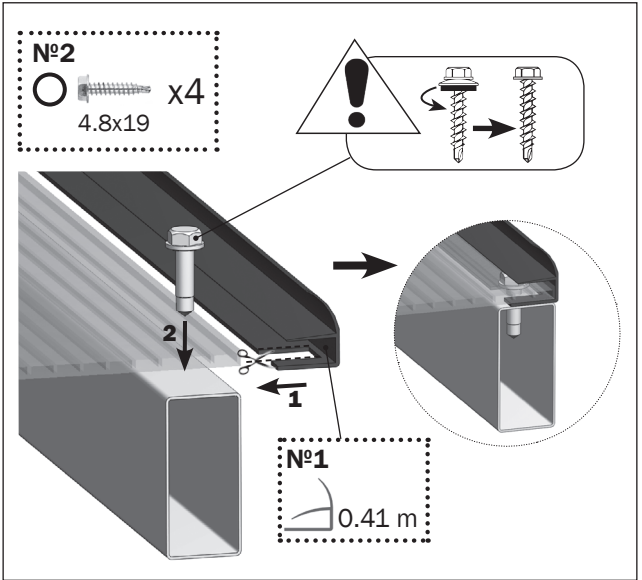

8

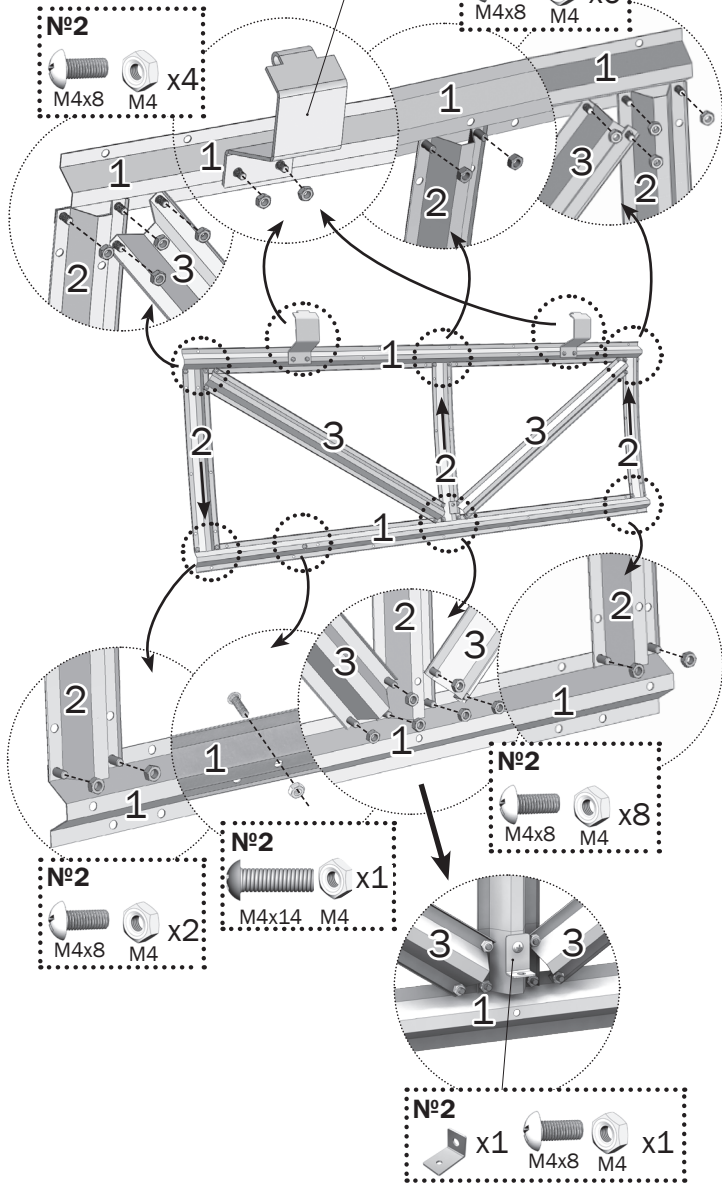
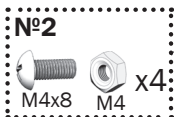
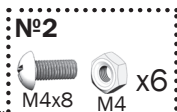
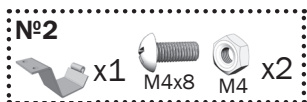

9

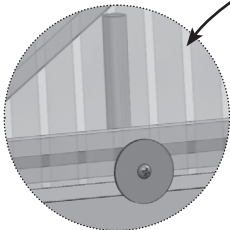
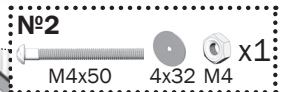
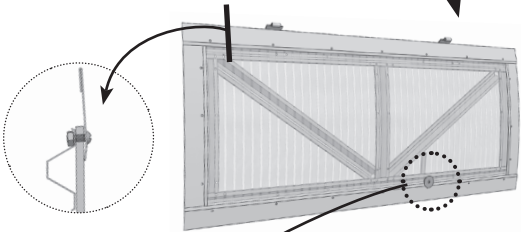
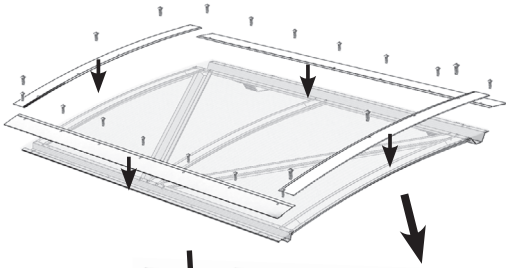
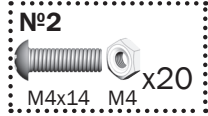
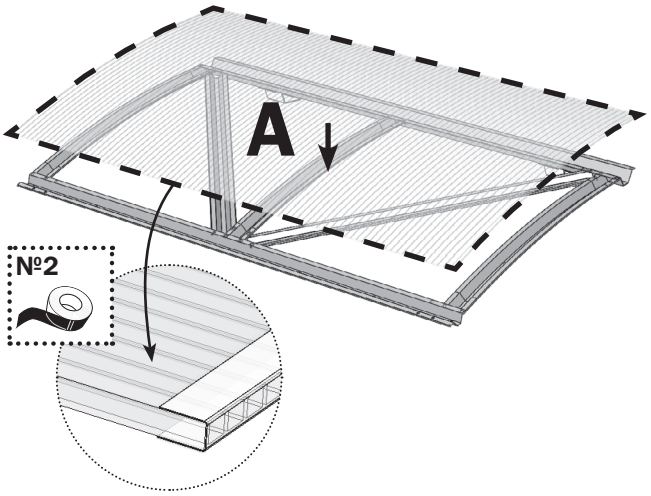

External view

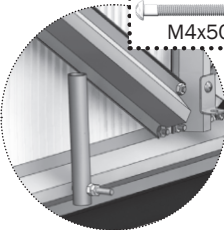

View inside

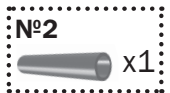

10

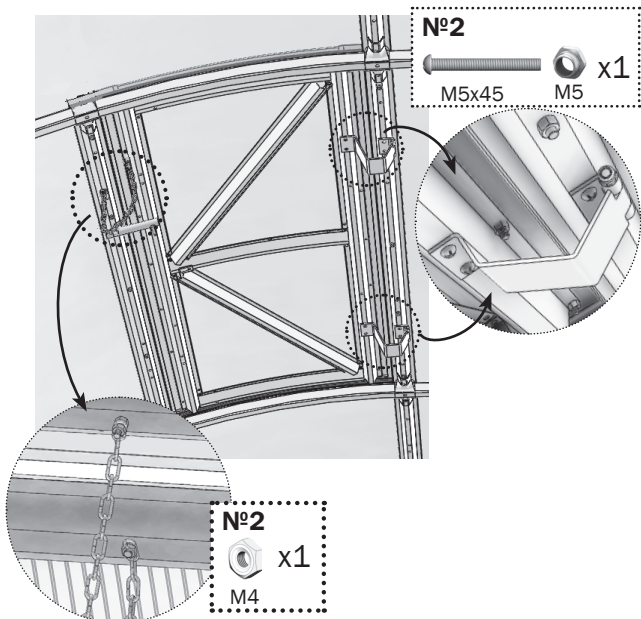

11

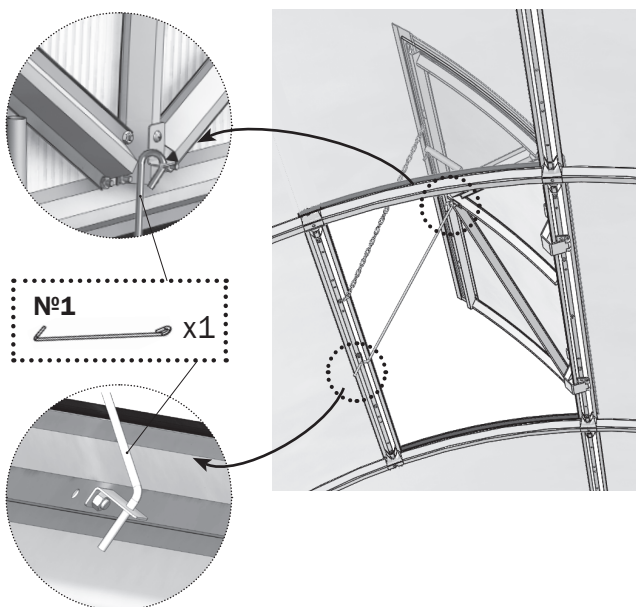



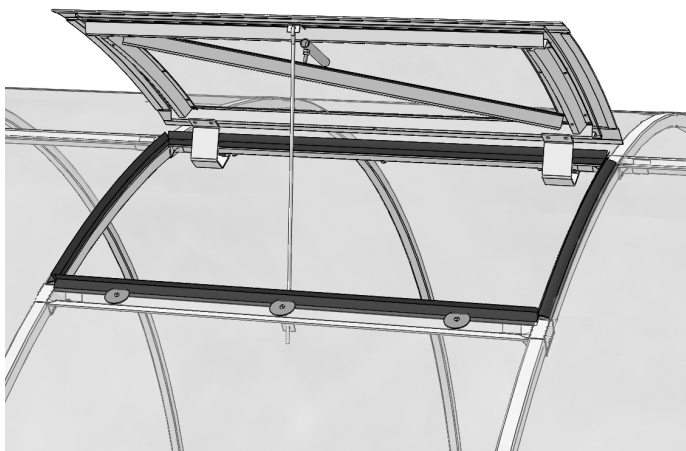



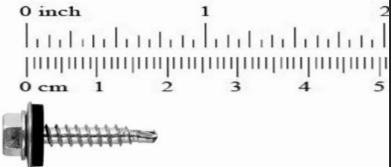

SMALL WINDOW
for the greenhouses «Sigma»
Step arcs 0.67 m





№1				
1	C.67.02		0.65 m	x1
2	1		0.61 m	x2
3	2		0.29 m	x2
4	3		0.59 m	x1
5	-		0.29 m	x1
6			0.33 m	x2
7			0.68 m	x2
8			0.68 m	x2
			0.41 m	x2
9			0.62 m	x2
№2				
10				x2
11				x1
12				x2
13				x2
14				x2
15				x1
16				x1

17	4,8x19		6
18	M4x8		31
19	M4x14		21
20	M4x35		10
21	M4x50		1
22	M5x45		2
23	M4		65
24	M5		2
25	32x4		11



3

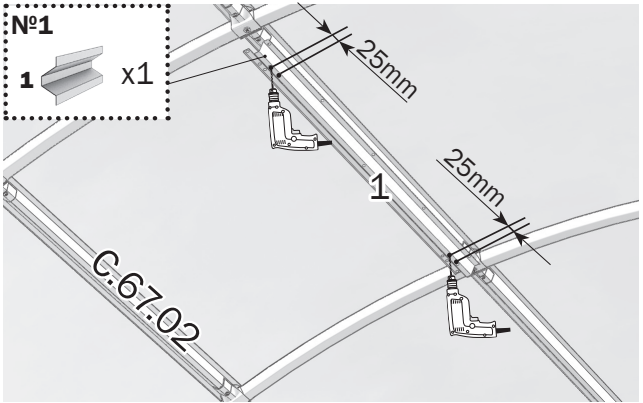

4

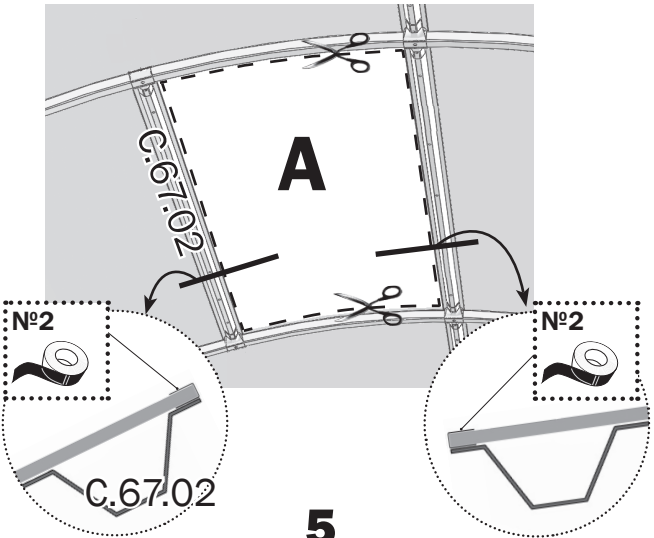

5

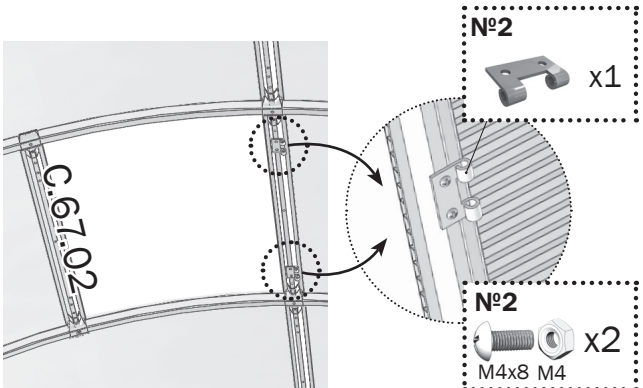

6

Nº2
M4x35 4x32 M4 x6

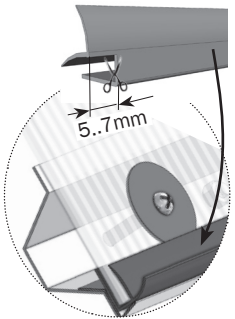
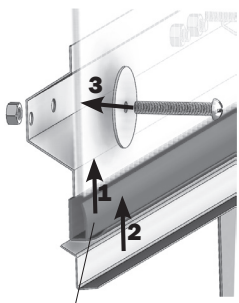

Nº1
0.68 m x1

External view

Ø5

5.7mm

C.67.02

Nº2 x1

Nº2 x1

View inside

View inside

7

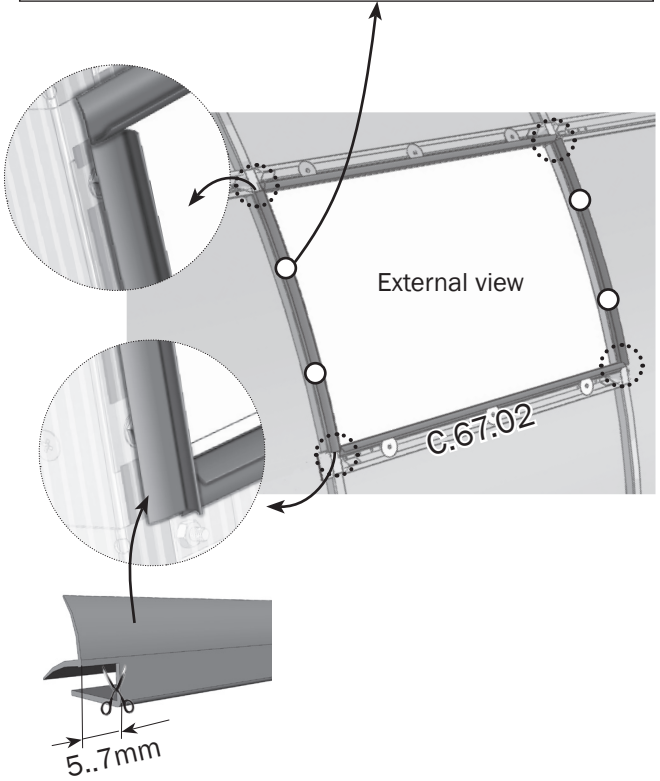
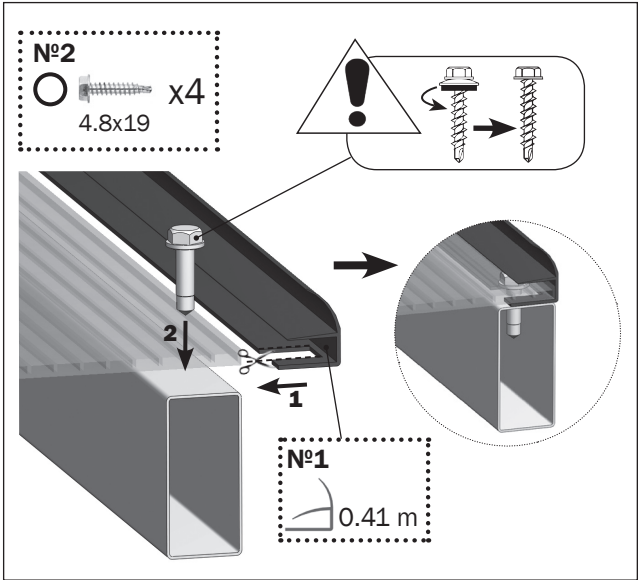

8

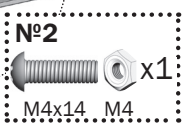
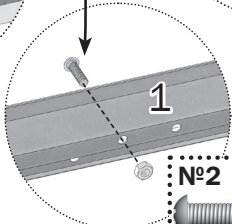
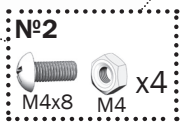
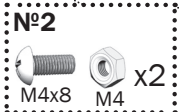
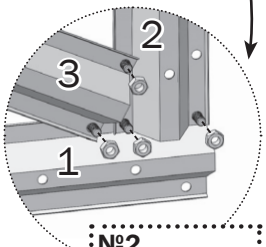
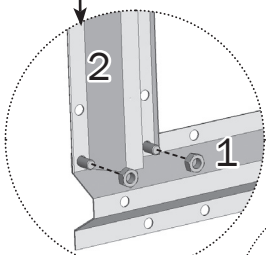
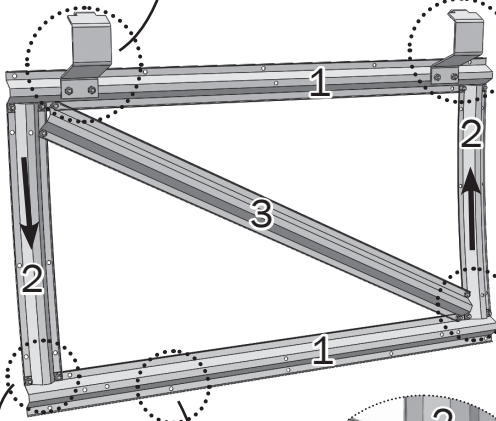
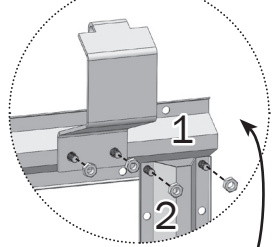
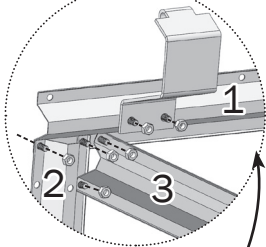

9

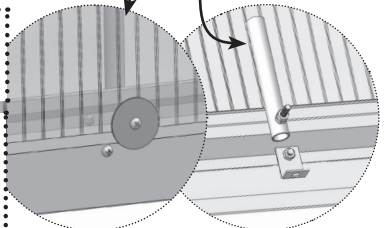
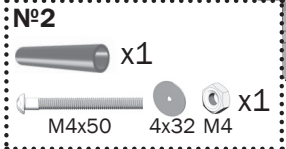
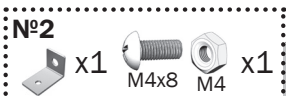
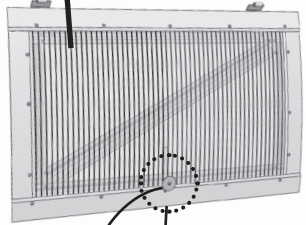
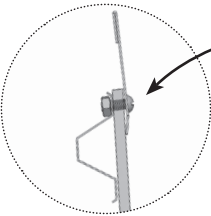
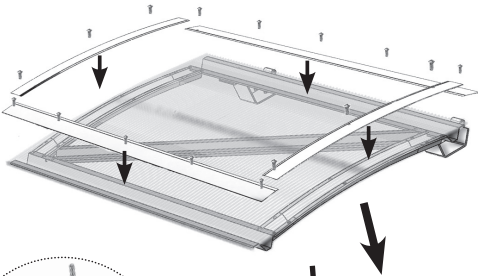
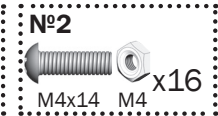
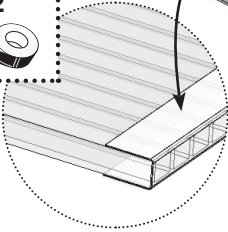
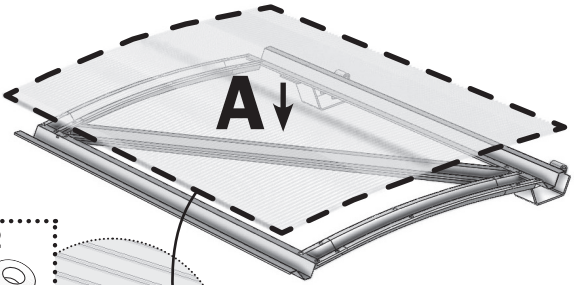

External view

View inside

10

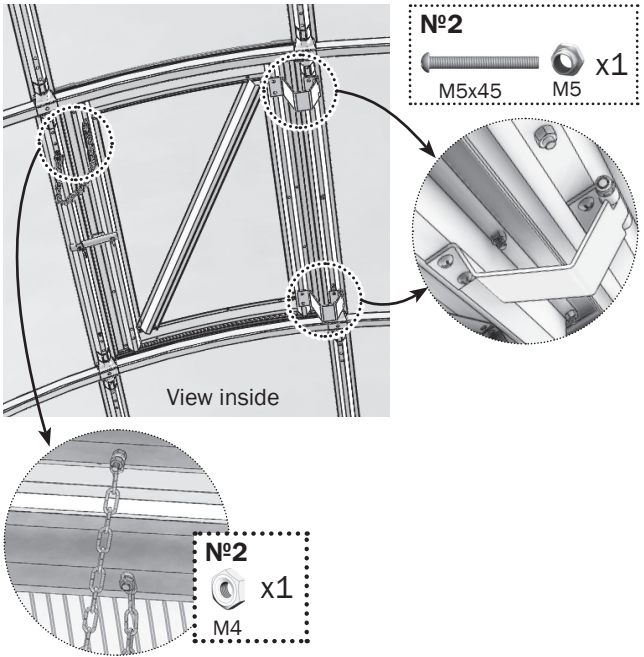

11

